



BS8620:2016

No: CE/21-22/112



# Assembly Manual Podium MAPD Series

# Aluminium Mobile Podium

## MAPD

BS8620:2016

This podium, **MAPD** is manufactured in our **ISO 9001** accredited facility.

This user guide provides you with step by step instructions to ensure your system is assembled easily and safely.



**WARNING**

NEVER FORGET TO LOCK THE  
CASTOR WHEELS

**DESCRIPTION:**

The Affix **MAPD** Series Mobile Podium are versatile and user-friendly aerial solution for all access needs. It gives a work platform for use by only one person. The Podium can be easily erected and with highly customizable assembly it meets almost all the site constraints and provides safe and efficient working platform.

The information and instructions included in this manual are provided to help get the best possible service from your **MAPD** Mobile Podium. This user guide provides you with step by step instructions to ensure your system is assembled easily and safely.

**Compliances:**

The Affix **MAPD** Mobile Tower structure and its components have been designed in accordance with BS8620:2016.

## Maximum Safe Working Loads

The safe working load of the tower is **600 kgs** including its own weight. The maximum safe working load of any individual platform is **250 kgs** evenly distributed. If the tower is to be used in an application outside the scope of **EN1004**, contact your supplier or the manufacturer, Affix Scaffolding WLL, for advice on loadings.

**Tel: +974 5529 9893 or Email: [info@affixscaffolding.com](mailto:info@affixscaffolding.com).**

### RECOMMENDATIONS :











- Recommend a minimum of two people to assemble, dismantle and move the platform tower.
- Check that all components are on site and in good working order.
- Ensure that the assembly location is checked to prevent hazards during assembly or moving and while working on the tower. Particular attention should be given to the ground condition, whether level or sloping, obstructions and wind conditions. The ground condition must be capable of supporting the tower structure.
- Towers must always be climbed from the inside of the assembly using the ladder.
- Lifting of components must be done inside the effective base area of the tower.
- Moving the tower is strictly NOT PERMISSIBLE. If required, dismantle and reassemble again.
- Beware of horizontal loads which can lead to instability of the tower. The Max. side force is 20kg.
- Outdoor scaffold towers should, wherever possible, be secured to a building or fixed structure. It is good practice to tie scaffold towers of any height, especially when unattended, or exposed to windy conditions.
- Do Not use boxes or steps to gain additional height.
- Do Not lift or suspend an assembled mobile tower.
- Damaged components or components from other tower systems must never be used.
- Stabilizers should always be fitted when specified. Use the stabilizer shown on the component list according to the tower height.

## Air speed and resultant action to be taken

Beaufort Scale	Description	Air Speed	Action to be taken
0	Calm, smoke rises easily upwards	1 mph	No action needed
3	Moderate breeze, raises dust	12 mph	No action needed, keep a watch
4	Raises loose papers, leaves and small twigs move	17 mph	Cease work
5	Strong breeze, tree branches bend, unable to use umbrella	25 mph	If expected, tie tower to a rigid structure
6	Gale force, cannot even walk	40 mph	If expected, dismantle the tower

## Safety Checklist :

### Mobile towers - 3T Method Checklist

- Inspect components prior to use 
- Inspect components prior to erection 
- Ensure all brace claws operate and lock correctly prior to erection 
- Tower upright and level 
- Castors locked and legs correctly adjusted 
- Diagonal braces fitted 
- Stabilizers/outriggers fitted as specified 
- Platforms located and wind-locks on 
- Toe boards located 
- Check that the guardrails are fitted correctly 

# SAFE WORKING LOADS AND HEIGHTS



- Safe working load on the working platform is **150kgs** evenly distributed.
- Maximum working height **2M** above the working platform.

## ASSEMBLY PROCESS :

### PREPARATION

- Locate the podium, ensuring ground is level.
- Make sure that the equipment is in good working order.
- Check the locking triggers in the bracing hooks such that they are working properly
- Lock the castor by moving the brake lever fully down.
- Also note that the horizontal and diagonal braces are differently color coded.
- Ensure all components are present and correctly fitted before use.

## Product Information

Working Height	<b>3 Mtr</b>
Platform Height	<b>1 Mtr</b>
Podium Height	<b>2 Mtr</b>
Podium Weight	<b>32 Kgs</b>
Podium Width	<b>0.8 Mtr</b>
Podium Length	<b>1.5 Mtr</b>
Platform Dimension	<b>0.70 Mtr x 0.70 Mtr</b>

## Step 1

### Step 1.1

Insert the 4 castor wheels inside the bottom of the tubes of the **Podium Frame**.

### Step 1.2

One person should hold the frame in upright position during this step.

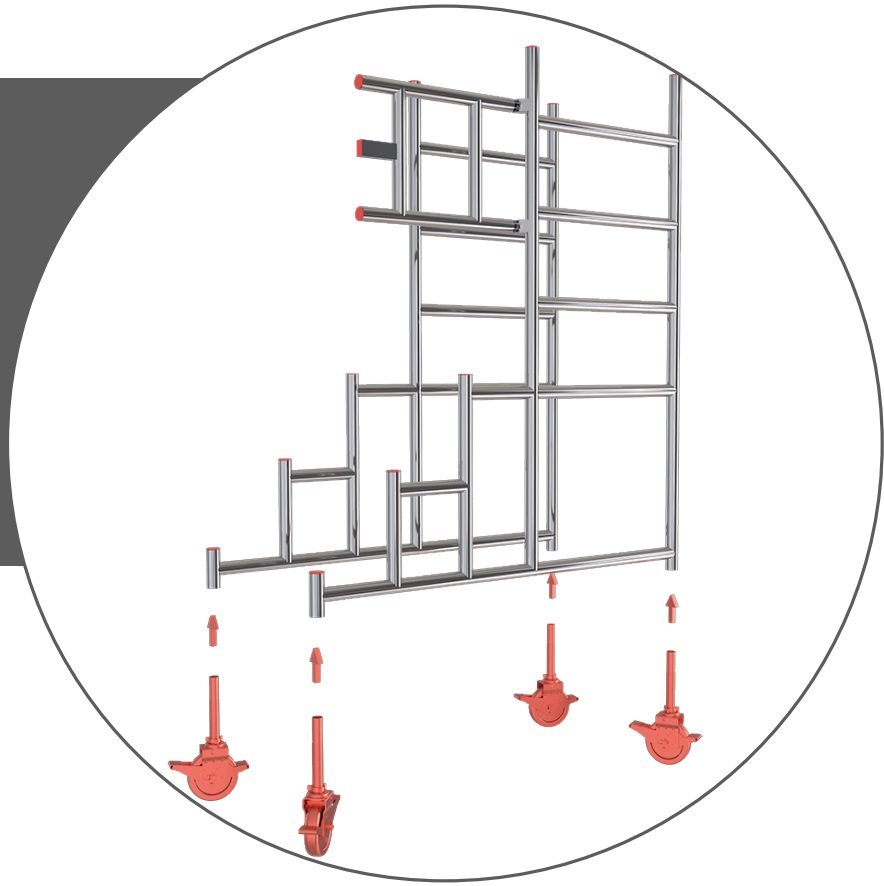

## Step 2

### Step 2.1

Hook one **Horizontal Bracing** in the front side on the **1st Rung** as shown in the image. Also hook the second **Horizontal Bracing** at the back side on the **1st Rung** of the **Podium Frame**.

### Step 2.2

One person should hold the frame in upright position during this step.

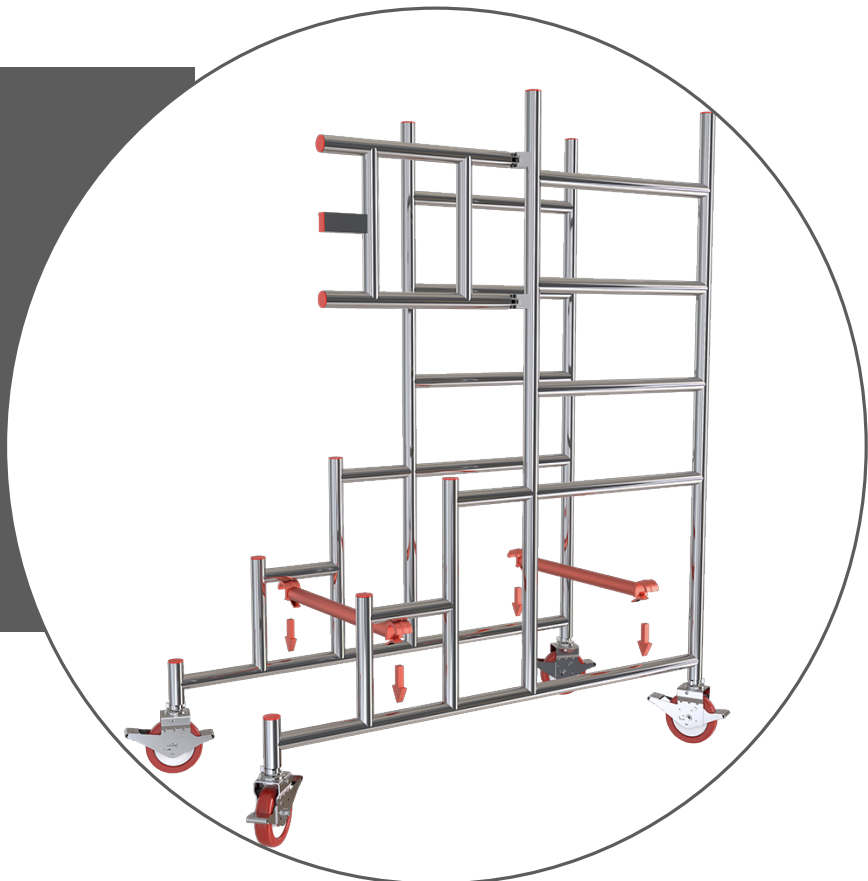

## Step 3

### Step 3.1

Hook one side of the Diagonal Bracing on the **1st Rung** as shown in the image and the other end on the **3rd Rung**. Also hook the **2nd Diagonal Brace** on the **1st Rung** as shown in the image and the other end on the **3rd Rung** of the **Podium Frame**.

### Step 3.2

Level the structure using a spirit level and make adjustments using the Adjustable Jack in the wheel.

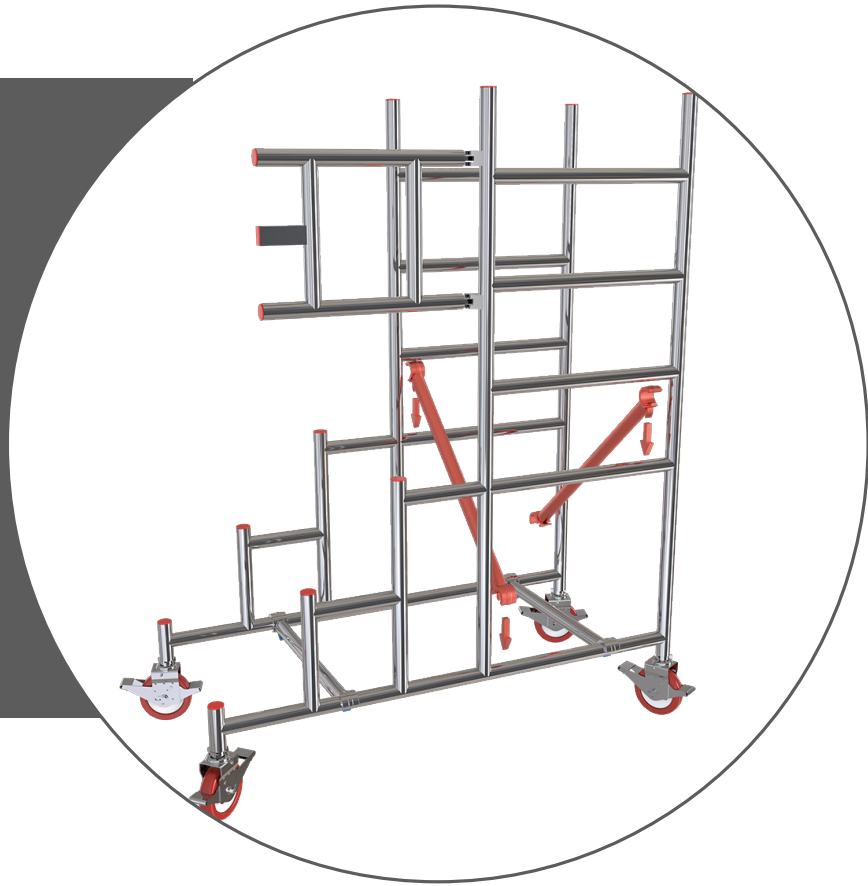

## Step 4

Fix the 1st platform on the 1st level as shown in the image

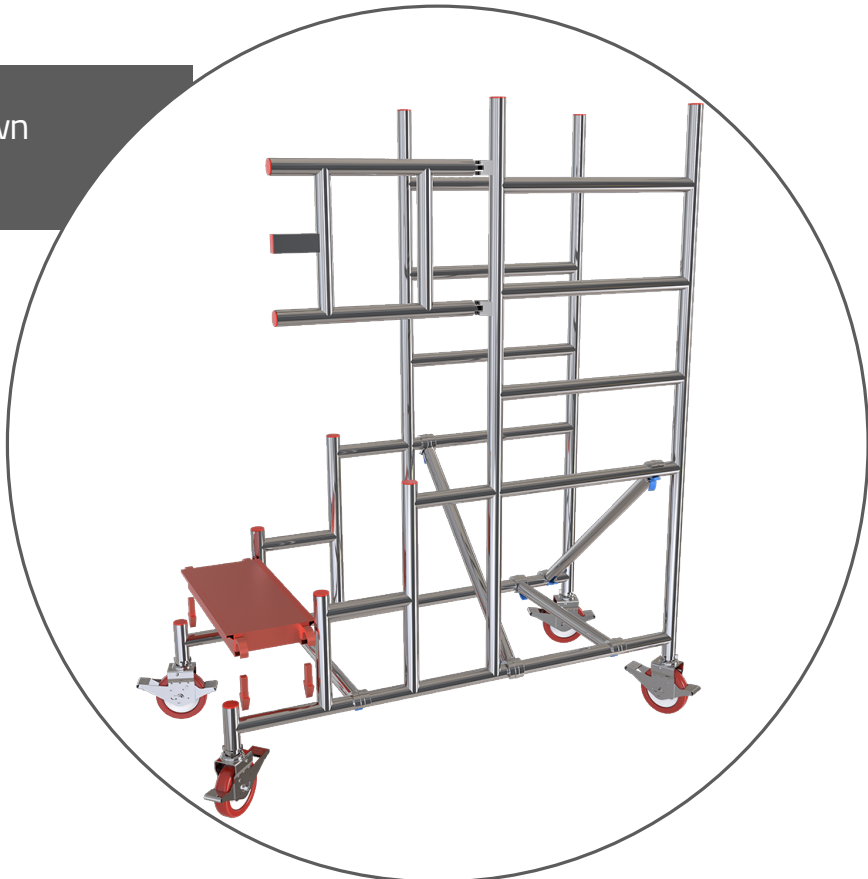



## Step 5

Fix the 2nd platform on the 2nd level as shown in the image.



## Step 6

Fix the 3rd platform on the 3rd level as shown in the image.



## Step 7

Fix the 4th platform which is the working platform on the 4th level as shown in the image.



## Step 8

Clamp the four stabilizers to the four corner posts.



## Step 9

### Step 9.1

Hook the **Horizontal Bracing** at the back side of the **5th Rung**.

### Step 9.2

Hook the **Horizontal Bracing** at the back side of the **6th Rung**.

These 2 horizontal braces will act as a guard rail for the podium



## Step 10

### Step 10.1

Fix the plastic toe board holders on all four corners of the working platform.

### Step 10.2

Insert the wooden toe board in the respective slots on the 3 sides (Front, left and right).



## Step 11

Make sure the side protection door is closed and latched once you are on the podium working platform.





Read the instructions. Ensure all components are present and correctly fitted before use



Inspect before use

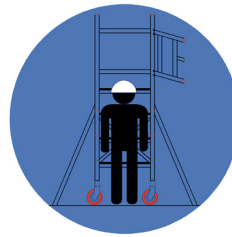

Face the access when ascending and descending



Do Not work near electric cables or other electrical equipments



Ensure all brakes are locked



Do Not use damaged components

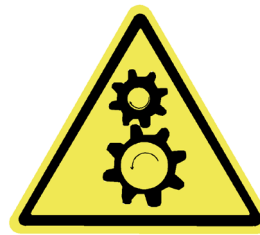

Beware of finger traps



Ensure side protection gate is closed and secure before use



Do Not Overreach



Do Not use on loose or slippery surfaces



Never move the structure when a person is on the working platform



Never more than one person on the tower



Never use as a means of access to another place



Do Not use on sloping or uneven surfaces, where the Podium is not fitted with a means of levelling the Podium, such as adjustable legs. Contact the manufacturer for further information

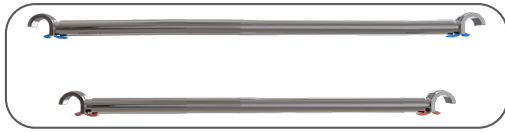

**BH & BD**

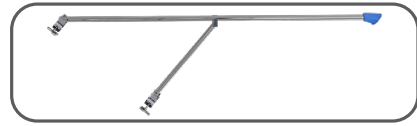

**Stabilizer**

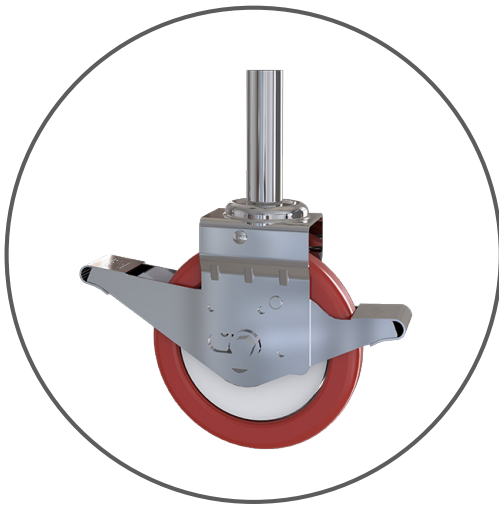

**CW150**  
Castor Wheel

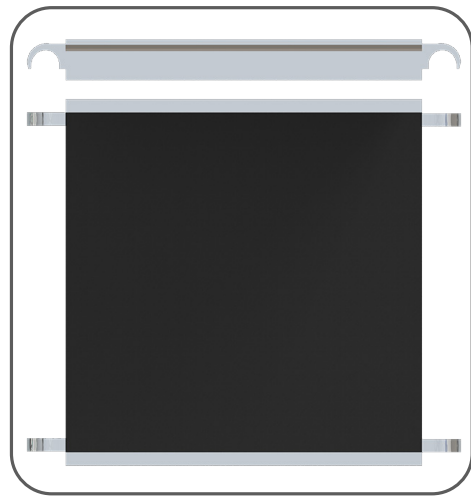

**PWP**

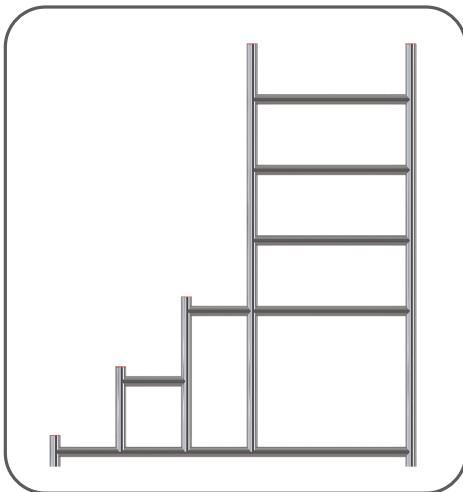

**FPM20**

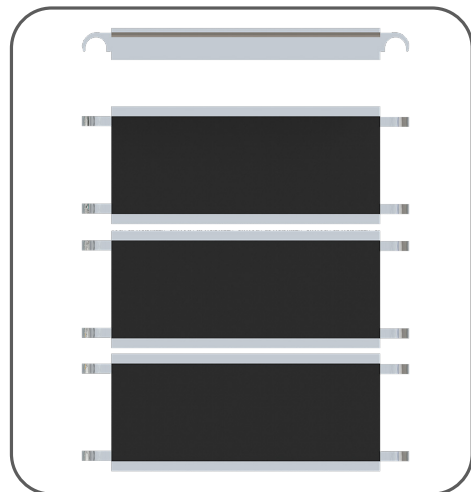

**PST 1-3**

# BS8620:2016 Certification by TUV India



## Statement of Confirmation

No.: CE/21-22/112

Client's Reference – EN-AS-AP-2122-000

Name & Address of the Manufacturer:

**AFFIX SCAFFOLDING.**

Hugo Building, Office No.13  
Opp Old Fatihima Shopping Centre  
Umm Dom Stree, Muaither, Doha , Qatar

Product Type: Low Level Work Platform

**Review Results/Observations:**

The Technical File referenced above submitted by the manufacturer has been reviewed for its document contents – the above product/s, generally comply with the Safety requirements of the British Standards:

### BS-8620:2016

**Validity:** 15 November 2024 (Subject to annual factory production control audits)



**Mahesh Gaur**  
General Manager - Product Certification and Product Testing Laboratory

(This Statement of Confirmation is valid under the conditions stated overleaf)



PO Box No. 201633 Doha, Qatar

Tel +974 4416 1483    Mobile +974 5529 9893

Mobile +974 3030 0685

EMail : [info@affixscaffolding.com](mailto:info@affixscaffolding.com)

Website: [www.affixscaffolding.com](http://www.affixscaffolding.com)

Website

SCAN ME

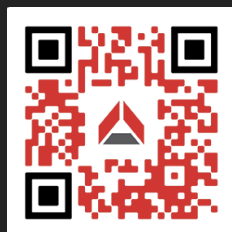

 <https://twitter.com/affixscaffoldin>

 <https://www.facebook.com/affixscaffoldin>

 <https://www.linkedin.com/company/affix-scaffolding-llc/>