

BS1139-6:2014

No: CE/21-22/046



# Assembly Manual

## Stair Towers MAST Series

# Aluminium Mobile Stair Towers

## MAST

BS1139-6 3 7/9 XXXD

The **AFFIX Tower** is a mobile access tower manufactured in our **ISO 9001** accredited facility.

This user guide provides you with step by step instructions to ensure your system is assembled easily and safely, using the **3T (Through the Trapdoor)** method.

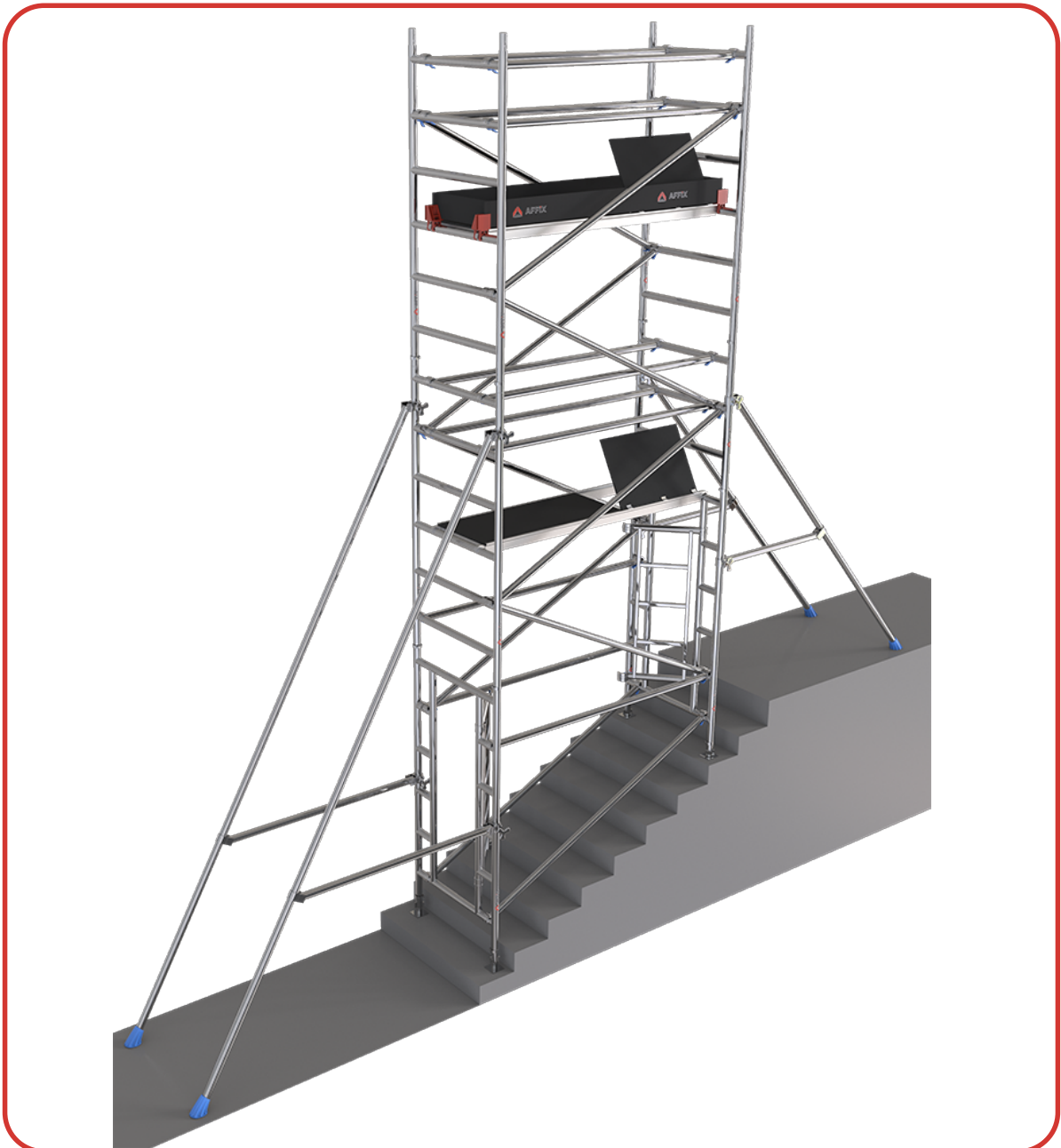

**WARNING**

NEVER FORGET TO LOCK THE  
CASTOR WHEELS

## DESCRIPTION:

Affix **MAST** Series Towers are versatile, user-friendly and safe portable access solution which is specifically designed for use on commercial and domestic staircases. It has a compact width of just 0.9 Mtr which enables easy transportation through standard doorways and stairways. It gives a work platform for use by a maximum of two people, with weight evenly distributed across the platform. The tower can be easily erected and with highly customizable assembly it meets almost all the site constraints and provides safe and efficient working platform. The key safety feature is the smart locking claws provided for the horizontal and diagonal bracings. It allows an instant lock-up performed by single hand use, however, with the reverse unlocking plug, two hands are needed to unplug the bracing.

The information and instructions included in this manual are provided to help get the best possible service from your **MAST** Series Tower. This user guide provides you with step by step instructions to ensure your system is assembled easily and safely, using the 3T (Through the Trapdoor) method.

## Through The Trapdoor (3T) Method:

The **3T** method of construction is an approved method of assembly and it minimizes the risk of a fall from height. The erector can complete an 'assembly or access' platform level from which the 'next lift' of frames, braces and platform is added, until the final working height of the tower is achieved. By following the **3T** method, the erector sits through the hatch of the platform with their feet resting on the frame rungs. In this position the erector can attach the guardrail braces. Once guard-rails are secured in position the erector can climb onto the platform and continue constructing the next level.

## Compliances:

The Affix **MAST** Mobile Tower structure and its components have been designed in accordance with BS1139-6: 2014.

## Maximum Safe Working Loads

The safe working load of the tower is **600** kgs including its own weight. The maximum safe working load of any individual platform is **200** kgs evenly distributed.

### RECOMMENDATIONS :









- Recommend a minimum of two people to assemble, dismantle and move the platform tower.
- Check that all components are on site and in good working order.
- Ensure that the assembly location is checked to prevent hazards during assembly or moving and while working on the tower. Particular attention should be given to the ground condition, whether level or sloping, obstructions and wind conditions. The ground condition must be capable of supporting the tower structure.
- Towers must always be climbed from the inside of the assembly using the ladder.
- Lifting of components must be done inside the effective base area of the tower.
- Moving the tower is strictly NOT PERMISSIBLE. If required, dismantle and reassemble again.
- Beware of horizontal loads which can lead to instability of the tower. The Max. side force is 20kg.
- Outdoor scaffold towers should, wherever possible, be secured to a building or fixed structure. It is good practice to tie scaffold towers of any height, especially when unattended, or exposed to windy conditions.
- Do Not use boxes or steps to gain additional height.
- Do Not lift or suspend an assembled mobile tower.
- Damaged components or components from other tower systems must never be used.
- Stabilizers should always be fitted when specified. Use the stabilizer shown on the component list according to the tower height.

## Air speed and resultant action to be taken

Beaufort Scale	Description	Air Speed	Action to be taken
0	Calm, smoke rises easily upwards	1 mph	No action needed
3	Moderate breeze, raises dust	12 mph	No action needed, keep a watch
4	Raises loose papers, leaves and small twigs move	17 mph	Cease work
5	Strong breeze, tree branches bend, unable to use umbrella	25 mph	If expected, tie tower to a rigid structure
6	Gale force, cannot even walk	40 mph	If expected, dismantle the tower

## Safety Checklist :

### Mobile towers - 3T Method Checklist

- Inspect components prior to use 
- Ensure all brace claws operate and lock correctly prior to erection 
- Tower upright and level 
- Diagonal braces fitted 
- Stabilizers/outriggers fitted as specified 
- Platforms located and wind-locks on 
- Toe boards located 
- Check that the guardrails are fitted correctly 

# SAFE WORKING LOADS AND HEIGHTS



- Safe working load on the working platform is **200kgs** evenly distributed.
- The load on the tower should not exceed **600 kgs**.
- The recommended tower height is **10M**.

## ASSEMBLY PROCESS :

### PREPARATION

Sort the braces into horizontal and diagonal braces, the diagonals are slightly longer. Also note that the braces are differently color coded.

Check the locking triggers in the bracing hooks such that they are working properly.

## FIRST LEVEL

### Step 1

#### Step 1.1

Insert the **Adjustable Jack** inside the bottom of the tubes of the 1st level **Walk-through Frame**.

#### Step 1.2

One person should hold the frame in upright position during this step.

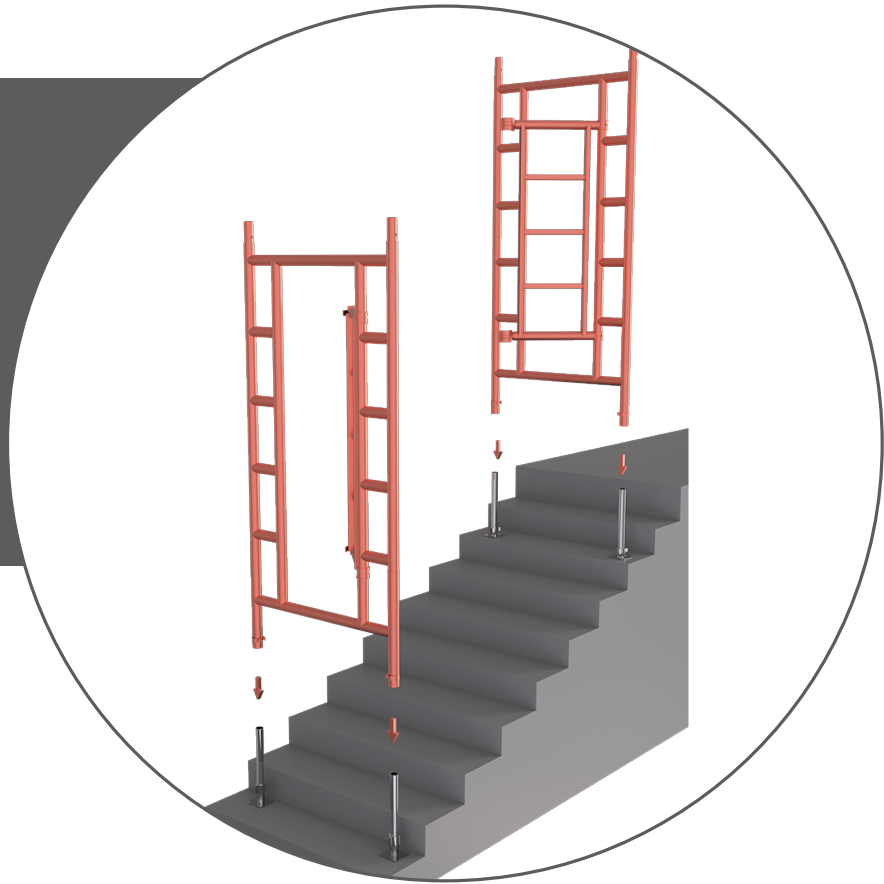

### Step 2

#### Step 2.1

Hook both the **Diagonal Braces** to the **1st Rung** of both the 1 level 6 rungs **Walk through Frames** on both the sides.

#### Step 2.2

One person should hold the frame in upright position during this step.

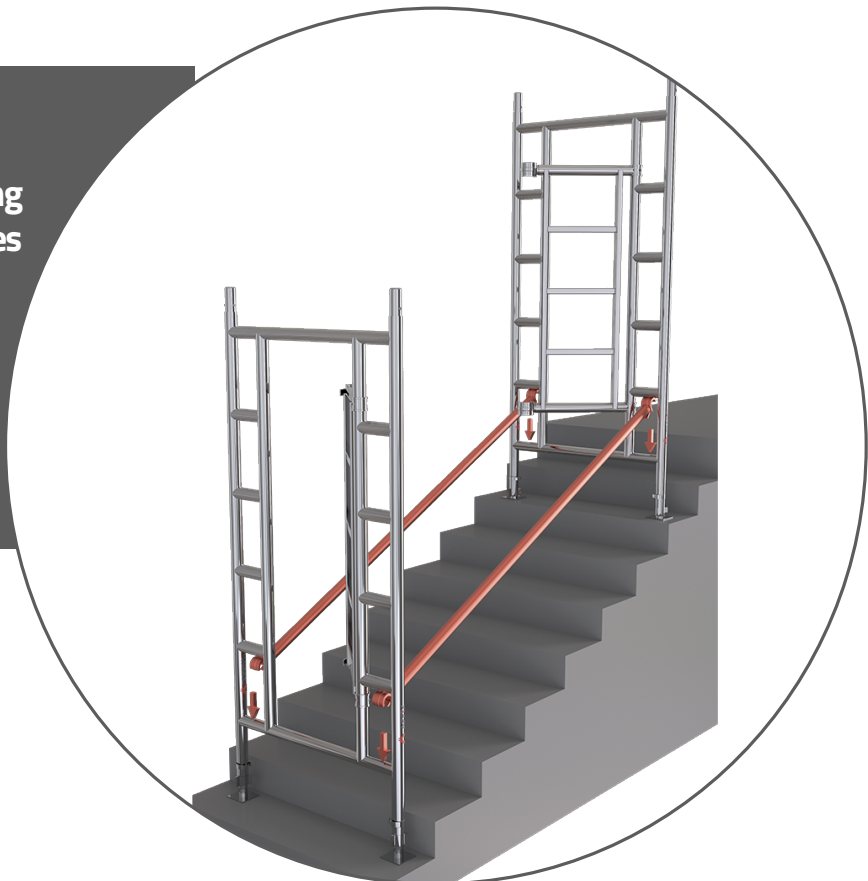

## SECOND LEVEL

## Step 3

Hook both the Horizontal Braces to the **2nd Rung** of upper level 6 rungs first level **Walk through Frame** and the other side to the **5th Rung** of the lower level 6 rungs first level **Walk through Frame**.

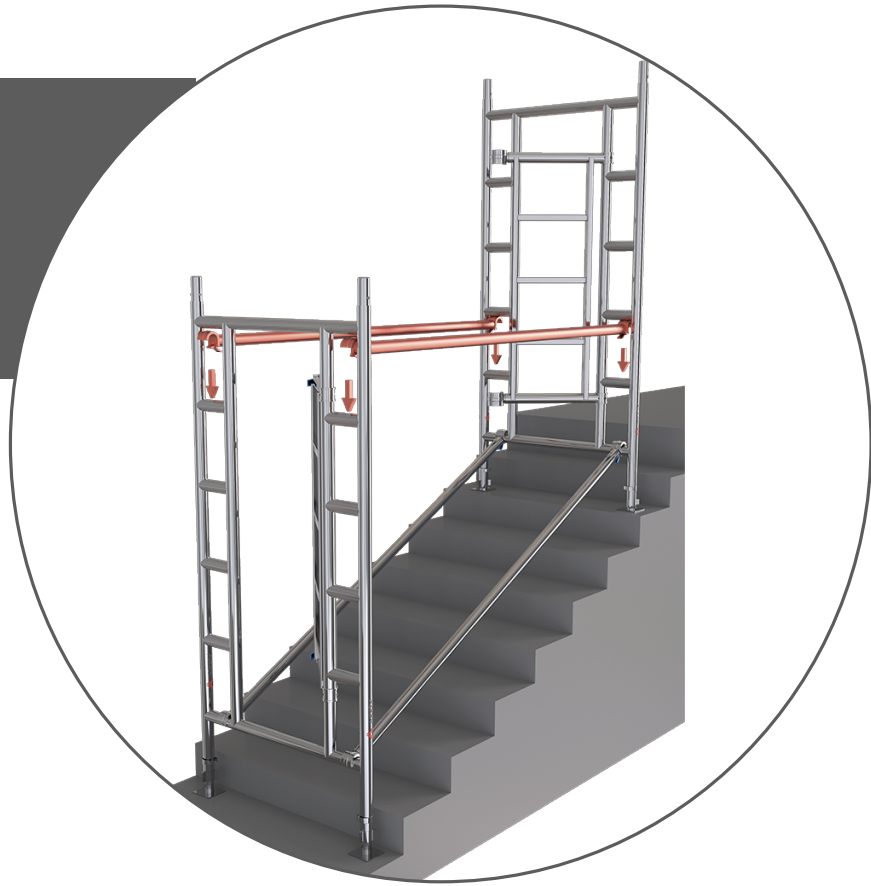

## Step 4

Adjust the level of the structure by using the **Adjustable Jack**. Use a spirit level on the horizontal braces to check the level.

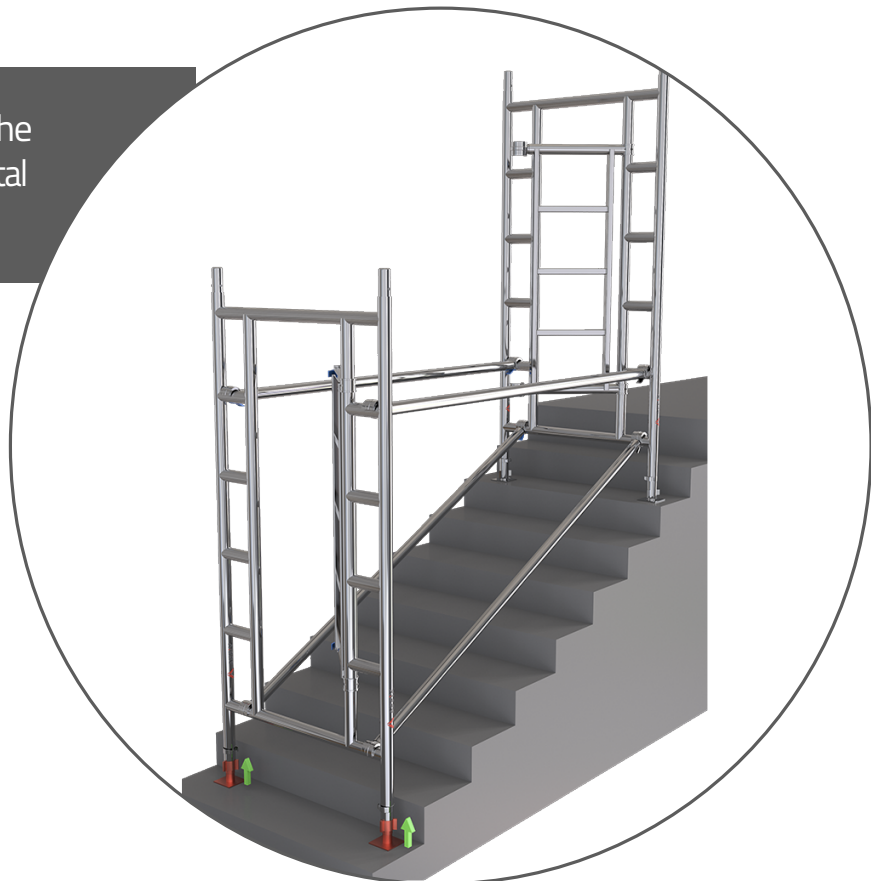



## Step 5

### Step 5.1

On the lower side, insert the 2nd level **6 rungs Span Frame** into the spigots of 1 level 6 rungs **Walk through Frame**.

For clamping instructions refer to the **Clamping Instructions** section on Page 15.

### Step 5.2

On the upper side side, insert the 2nd level **3 rungs Span Frame** into the spigots of 1st level 6 rungs **Walk through Frame**. For clamping instructions refer to the **Clamping Instructions** section on Page 15.

**Warning:** **DO NOT** swap the sides of the frames for the 2nd level.

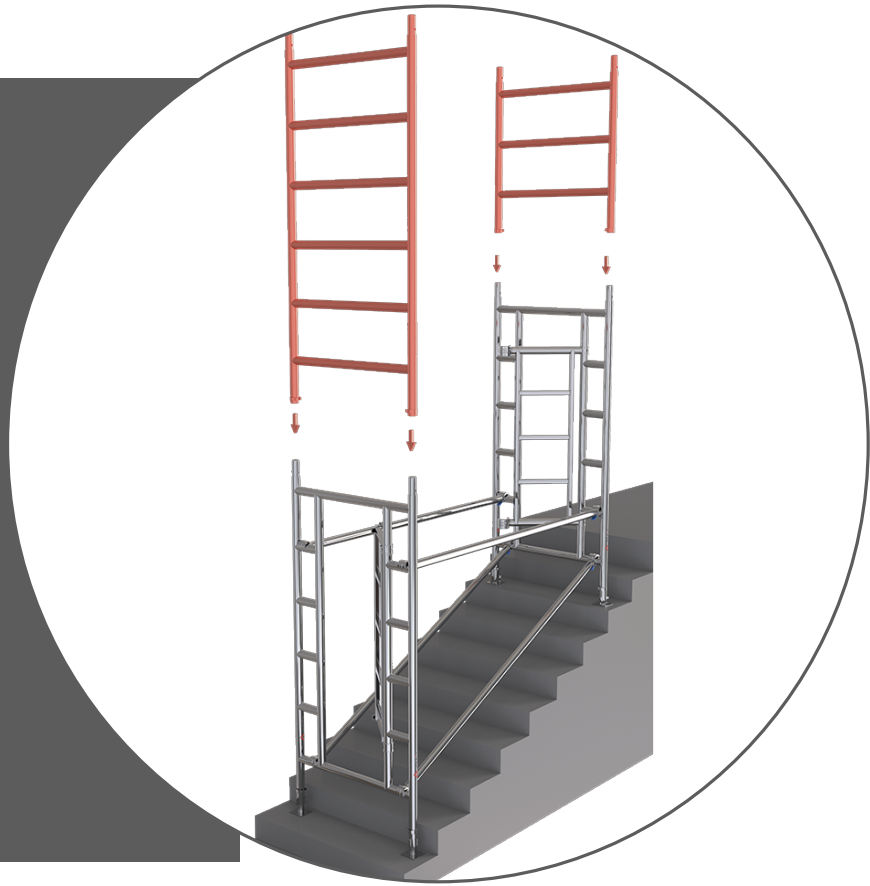

## Step 6

### Step 6.1

Hook one side of the **Diagonal Brace** to the **2nd Rung** of the 1st level 6 rungs **Walk through Frame** on the upper side and the other side of the **Diagonal Brace** to the **2nd Rung** of the 2nd level 6 rungs **Span Frame** on the lower side.

### Step 6.2

Hook the other **Diagonal Brace** to the **5th Rung** of both the 1st level 6 rungs **Walk through Frame**.

### Step 6.3

Hook one side of the **Horizontal Brace** to the **4th Rung** of 1st level 6 rungs **Walk through Frame** on the upper side and the other side of the **Horizontal Brace** to the **1st Rung** of the 2nd level 6 rungs **Span Frame** on the lower side.

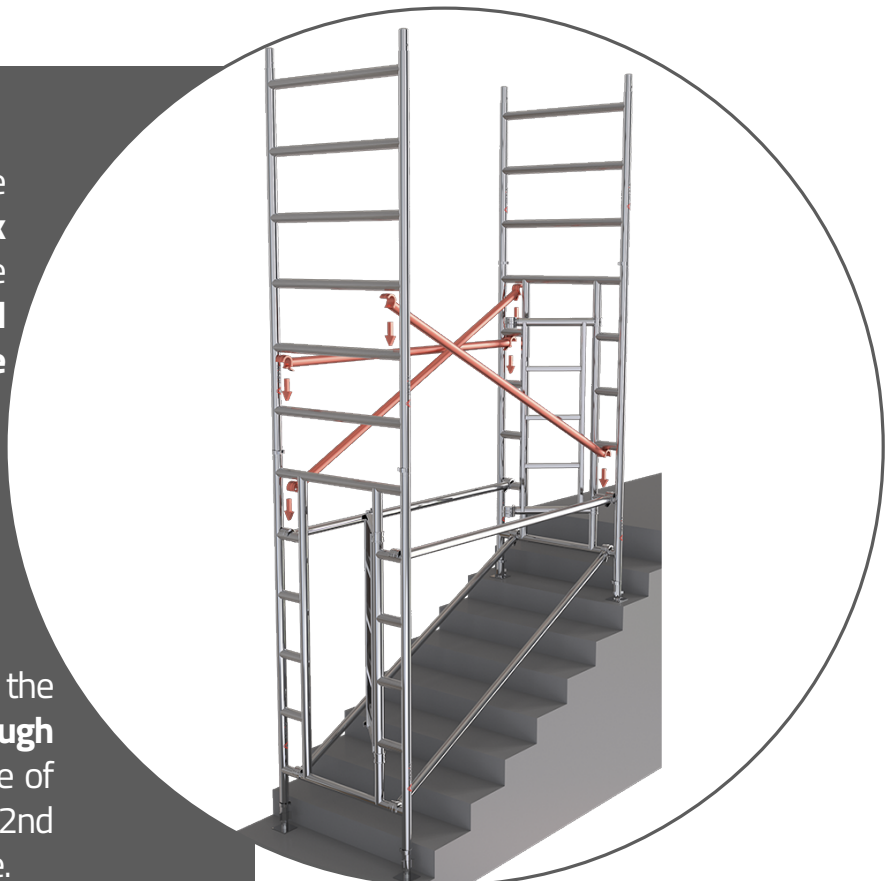

## Step 7

Clamp the 2 Stabilizers on the 2 sides towards the lower side as instructed in detail on **Page no.17**.

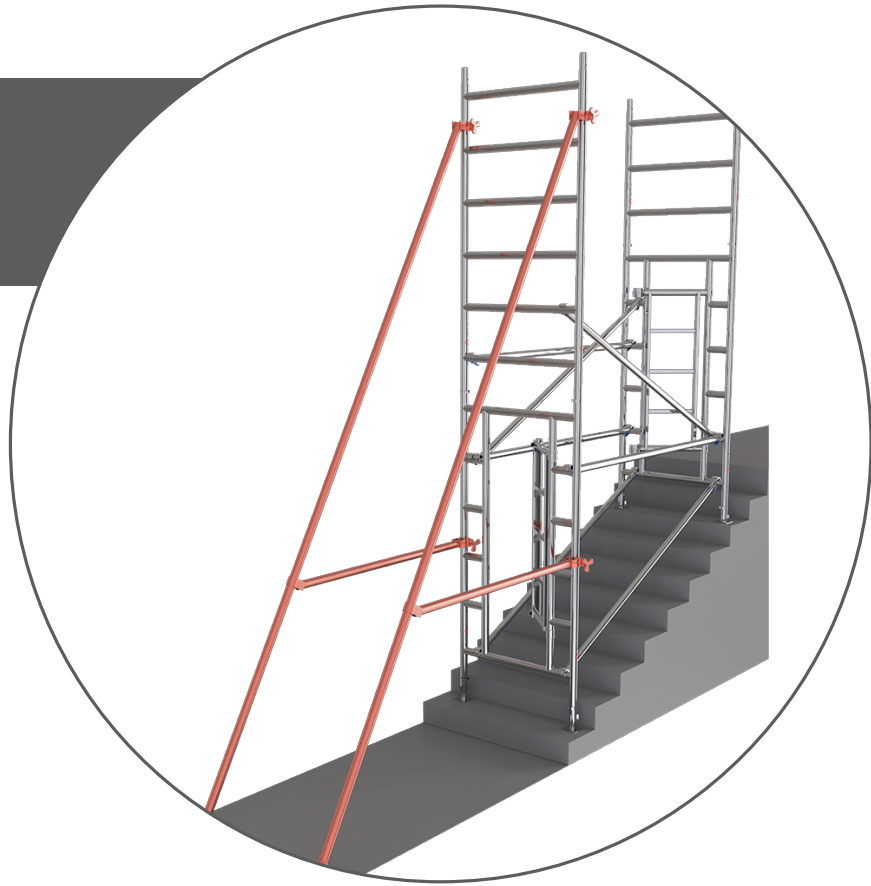

## Step 8

Clamp the 2 Stabilizers on the 2 sides towards the upper side as instructed in detail on **Page no.17**.

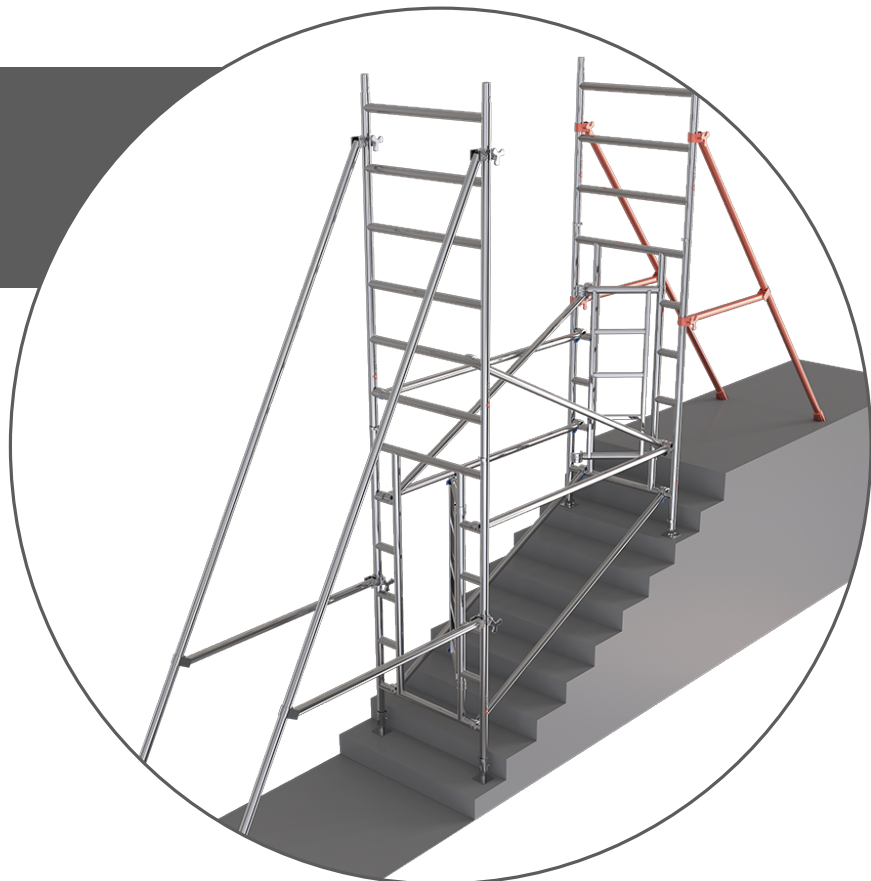

## Step 9

Hook the **Intermediate Platform** on the **6th Rung** of 1st level 6 rungs **Walk through Frame** on the upper side and the other side of the **Platform** to the **3rd Rung** of the 2nd level frame 6 rungs **Span Frame** on the lower side.

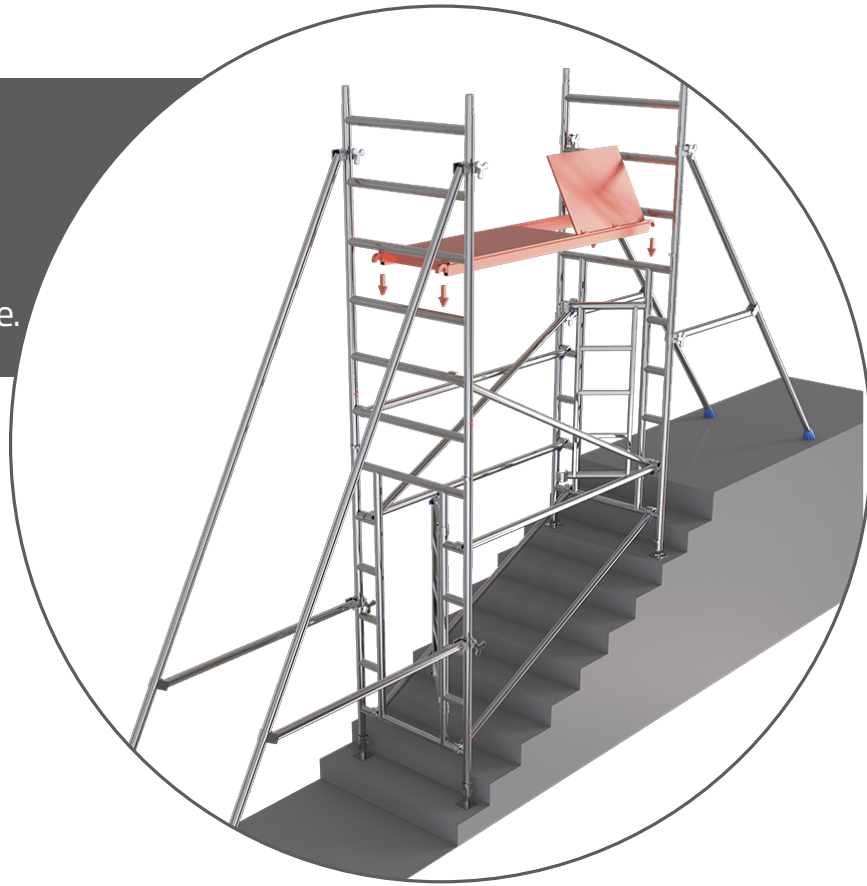

## Step 10

### Step 10.1

Hook one side of the **Diagonal Brace** to the **2nd Rung** of the 2nd level 3 rungs **Span frame** on the upper side and the other side of the **Diagonal Brace** to the **2nd Rung** of the 2nd level 6 rungs **Span Frame** on the lower side.

### Step 10.2

Hook one side of the **Diagonal Brace** to the **5th Rung** of the 1st level 6 rungs **Walk through Frame** on the upper side and the other side of the **Diagonal Brace** to the **5th Rung** of the 2nd level frame **6 rungs Span Frame** on the lower side.

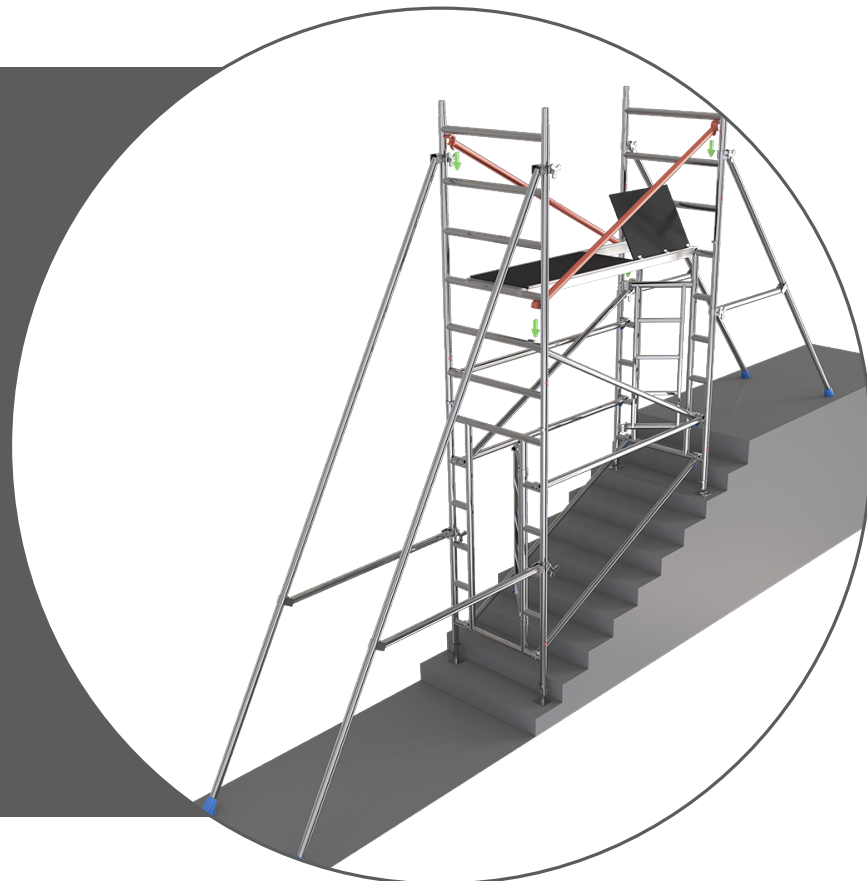

## Step 11

### Step 11.1

Hook the lower pair of **Horizontal Braces** to the **2nd Rung** of 2nd level 3 rungs **Span frame** on the upper side and the other side of the **Horizontal Braces** to the **5th Rung** of the 2nd level 6 rungs **Span frame** on the lower side.

### Step 11.2

Hook upper pair of **Horizontal Braces** to the **3rd Rung** of 2nd level frame 3 rungs Span Frame on the upper side and the other side of the **Horizontal Braces** to the **6th Rung** of the 2nd level 6 rungs Span Frame on the lower side.



## THIRD LEVEL

## Step 12

### Step 12.1

On the lower side, insert the **3rd level 6 rungs Span Frame** into the spigots of the 2nd level 6 rungs **Span Frame**.

For clamping instructions refer to the **Clamping Instructions section on Page 15**.

### Step 12.2

On the upper side side, insert the **3rd level 6 rungs Span Frame** into the spigots of 2nd level 3 rungs **Span Frame**.

For clamping instructions refer to the **Clamping Instructions section on Page 15**.

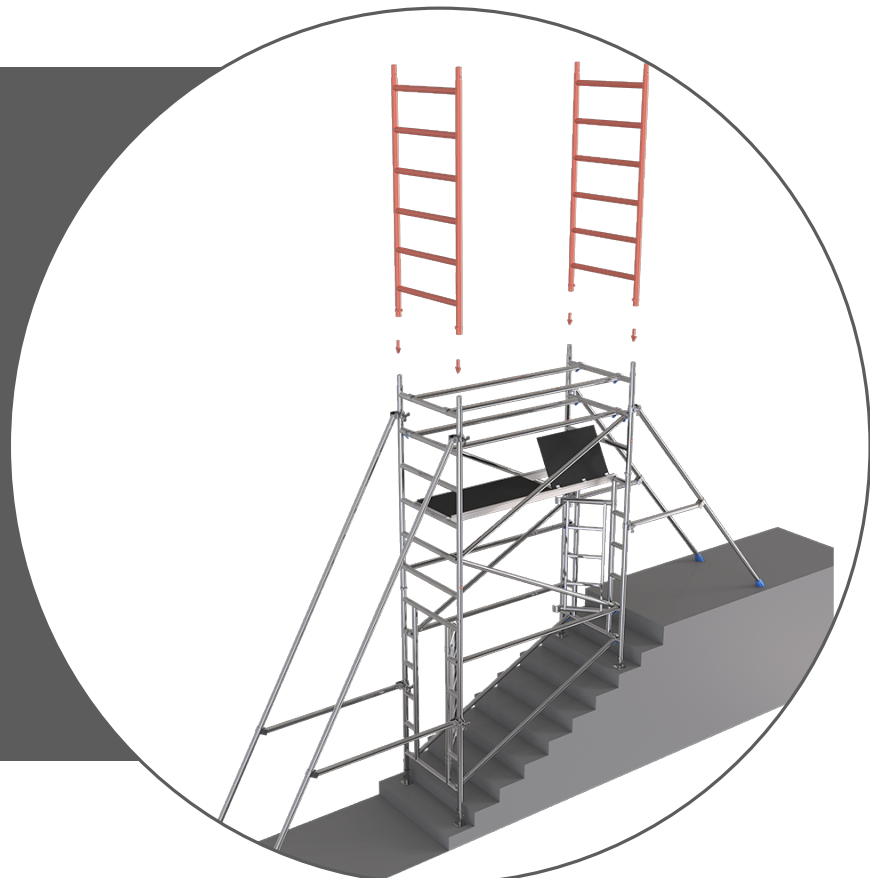

## Step 13

### Step 13.1

Hook one side of the **Diagonal Brace** to the **2nd Rung** of the 2nd level 3 rungs **Span frame** on the upper side and the other side of the **Diagonal Brace** to the **2nd Rung** of the 3rd level 6 rungs **Span Frame** on the lower side.

### Step 13.2

Hook one side of the **Diagonal Brace** to the **5th Rung** of the 2nd level 6 rungs **Span Frame** on the lower side and the other side of the **Diagonal Brace** to the **2nd Rung** of the 3rd level 6 rungs **Span frame** on the upper side.

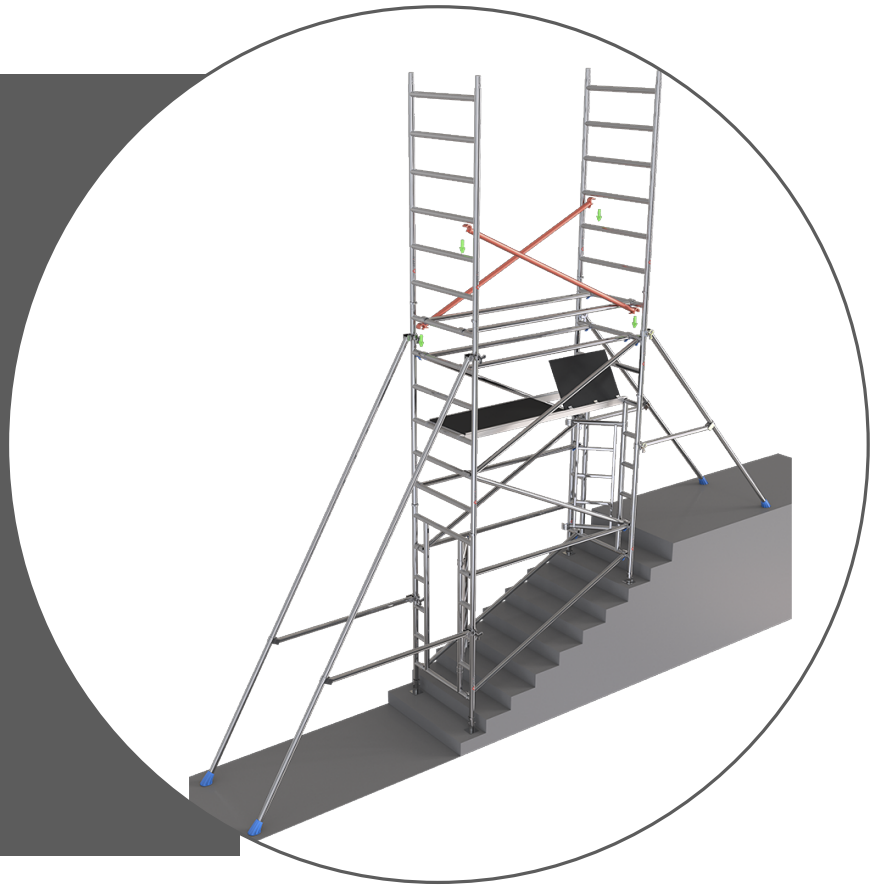

## Step 14

Hook the **Working Platform** on the **3rd Rung** of 3rd level 6 rungs **Span Frame** on both the sides. Ensure the trap-door is on the same side as that of the Intermediate Platform.

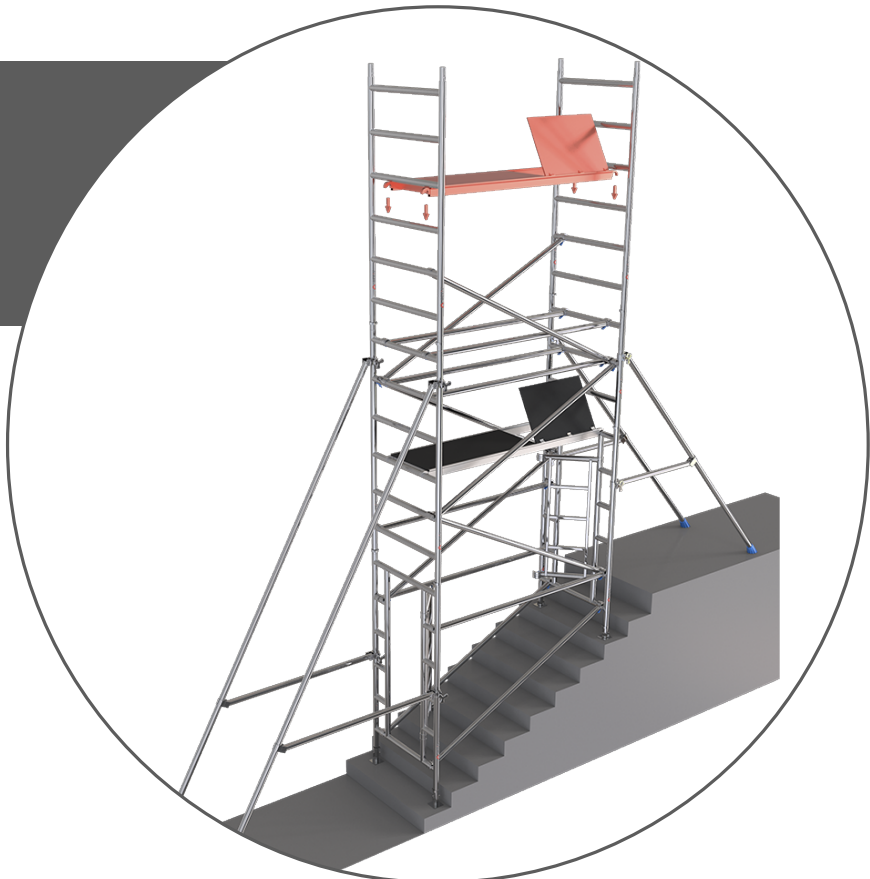

## Step 15

### Step 15.1

Hook one side of the **Diagonal Brace** to the **5th Rung** of the 3rd level 6 rungs **Span Frame** on the upper side and the other side of the **Diagonal Brace** to the **2nd Rung** of the 3rd level 6 rungs **Span Frame** on the lower side.

### Step 15.2

Hook one side of the **Diagonal Brace** to the **2nd Rung** of the 3rd level 6 rungs **Span Frame** on the upper side and the other side of the **Diagonal Brace** to the **5th Rung** of the 3rd level 6 rungs **Span frame** on the lower side.

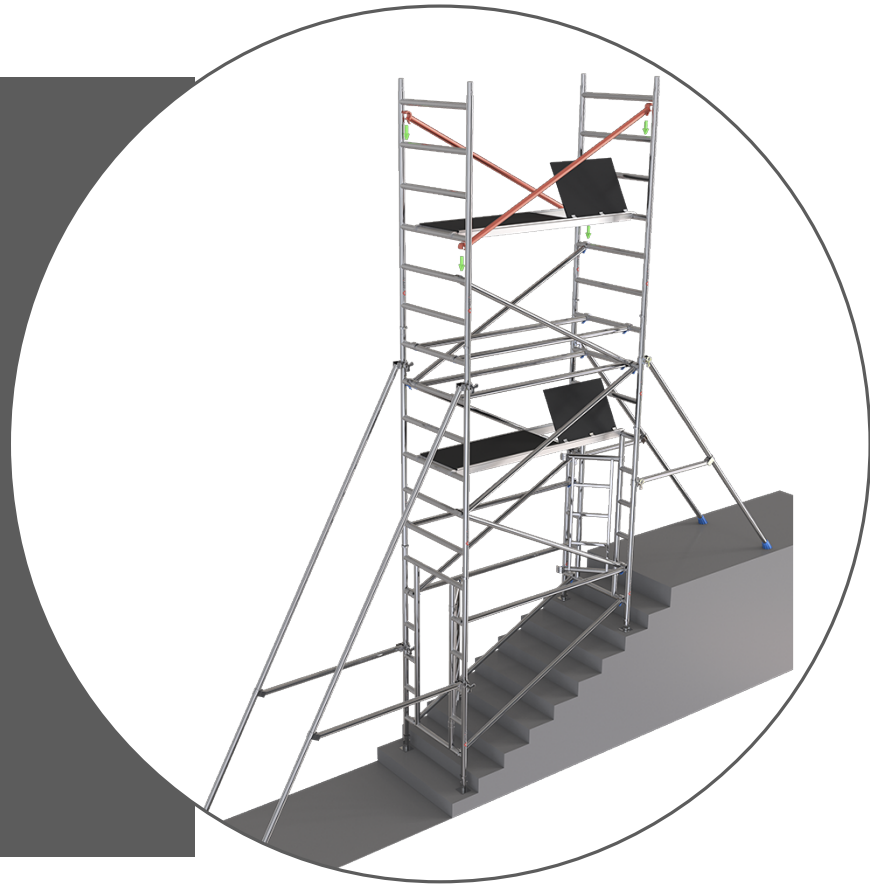

## Step 16

### Step 16.1

Hook the lower pair of **Horizontal Braces** to the **5th Rung** of 3rd level 6 rungs **Span Frame** on both the sides.

### Step 16.2

Hook the upper pair of **Horizontal Braces** to the **6th Rung** of 3rd level 6 rungs **Span Frame** on both the sides.

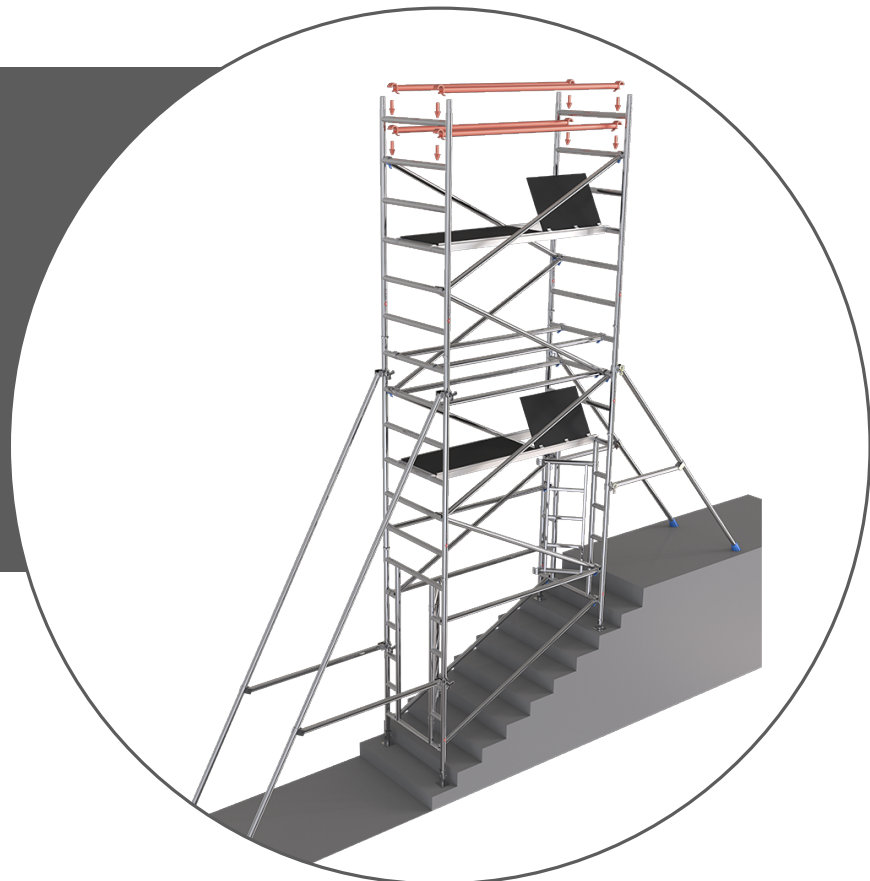

**Step 17****Step 17.1**

Clamp the 4 plastic toe-board holders on all the 4 corners of the working platform level, around the working platform.

For more details, refer to **Toeboard Assembly** details on **Page 15**.

**Step 17.2**

Insert the wooden toe-boards in the toe-board holder on all the 4 sides.

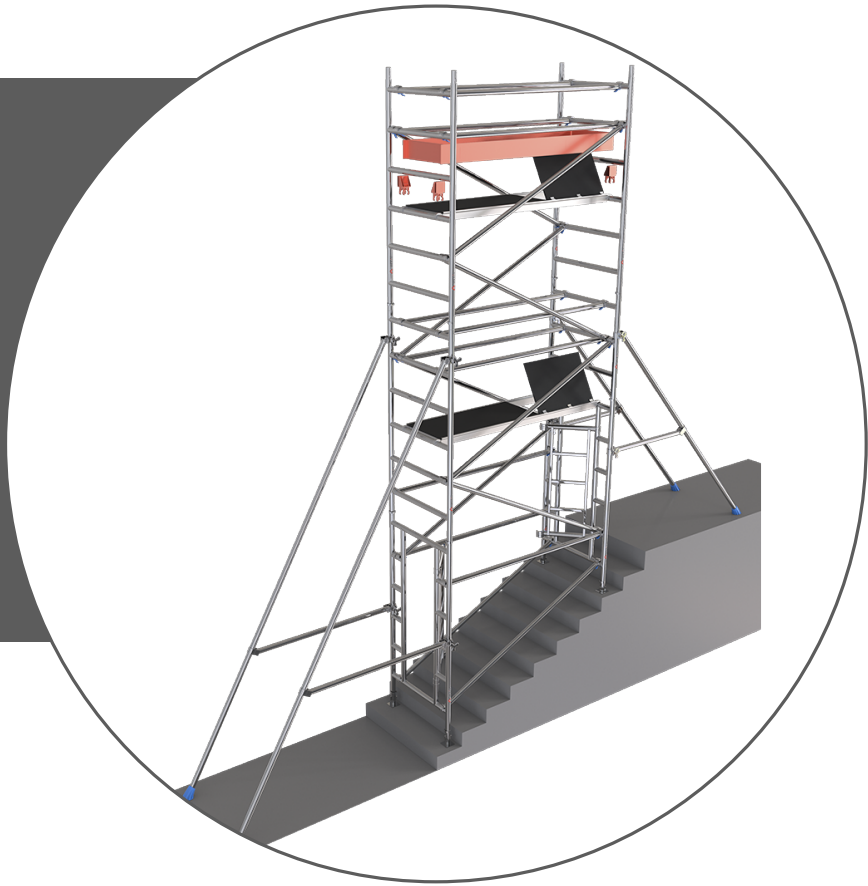

## Toeboard Assembly Details

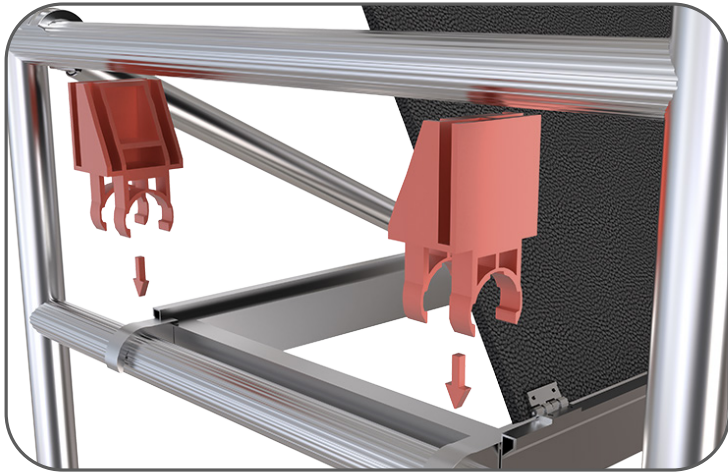

Fix the claw of the Toeboard **TB** on the **Rungs** facing each other as shown in the figure.

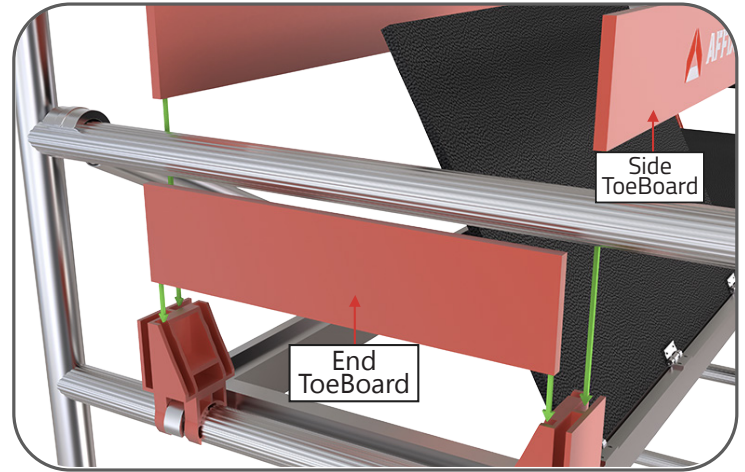

Then insert the **Side Toeboard** and the **End Toeboard** in the respective toeboard slots as shown in the figure.

## Clamping Instructions

Always ensure the **Spring Clips** are in the lock position after inserting the upper frame in the **Spigot**. To insert, unlock the **Spring Clip**.

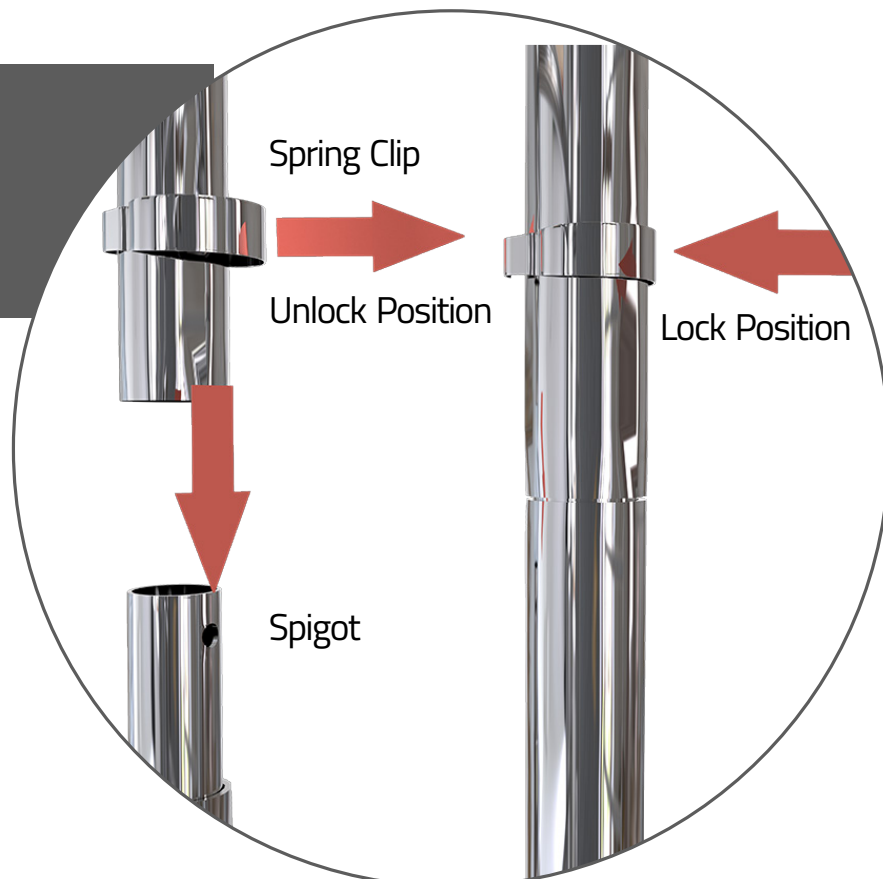





**JA500**



**FW20900**

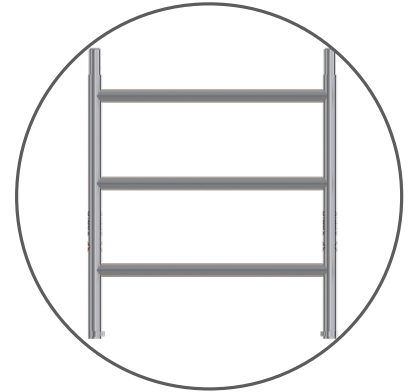

**FM10900**

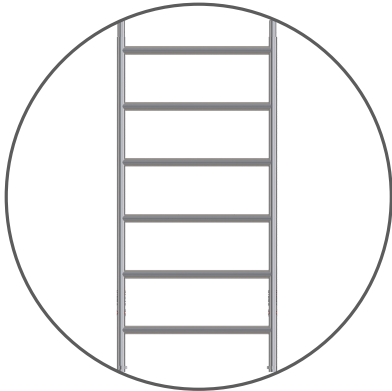

**FM20900**

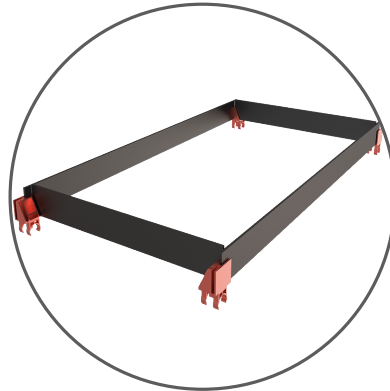

**BT200/250**  
ToeBoard Set



**ST200/300/450/600**  
Stabilizer



**PT200/250**  
Trapdoor Platform



**BD200/250, BH200/250**  
Diagonal Brace, Horizontal Brace

Stabilizers are to be used, when specified, to guarantee the structural stability of the tower.

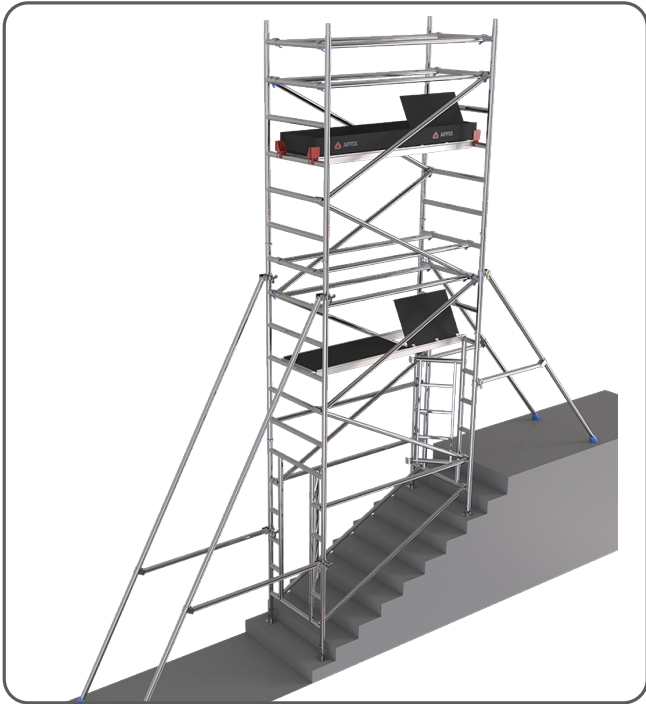

**Fig. 01**

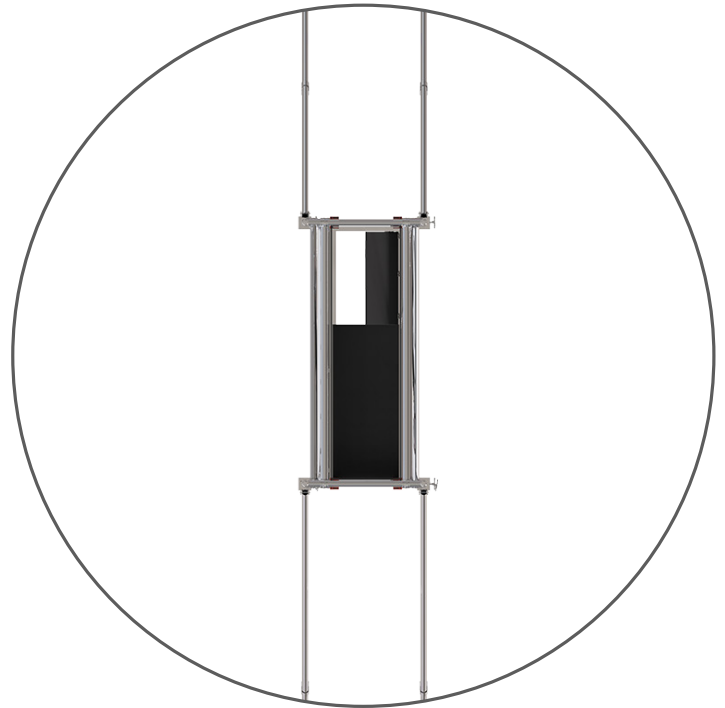

**Fig. 02**

## **Fig. 01**

Lightly tighten the upper clamp of the stabilizer on each corner vertical posts at a height where the foot is touching the ground. Position the clamp of the lower arm such that the lower arm is as horizontal as possible.

## **Fig. 02**

Position the stabilizers so that the footpads are approximately equidistant from each other in pairs of two (opposite sides).

## Moving the Tower

**Moving the tower is strictly NOT Permissible. If required, dismantle and re-assemble again.**

## Comply To

- Independently tested for use.
- Compliant to 3T Assembly process.
- Safe working load on the platform is 200kgs/Sq Mtr, evenly distributed.
- Maximum permissible distributed load on the tower 600 Kgs.

## Type Approval

The scaffold towers referred to herein have been tested by



## MAST SERIES TABLE Confirming to BS1139-6:2014

### ALUMINIUM MOBILE STAIR TOWER

	MAST	420	620	820	1020	
Tower Height	in Mtrs	4.0	6.0	8.0	10.0	
Working Height	in Mtrs	5.0	7.0	9.0	11.0	
Platform Height	in Mtrs	3.0	5.0	7.0	9.0	
Weight	in Kgs	104	125	166	206	
Components	Code	Specs				
Walkthrough Frame	FW20900	2.0 Mtrs	2	2	2	2
Span Frame	FS20900	2.0 Mtrs	1	3	5	7
Span Frame	FS10900	1.0 Mtrs	1	1	1	1
Adjustable Jack with Base Plate	JA500	0.5 Mtr	4	4	4	4
Horizontal Braces	BH200	2.0 Mtr	7	11	15	19
Diagonal Braces	BD200	2.2 Mtrs	6	10	14	18
Stabilizer	ST200	2.0 Mtrs	2	0	0	0
Stabilizer	ST300	3.0 Mtrs	2	2	2	2
Stabilizer	ST450	4.5 Mtrs	0	2	2	2
Stabilizer	ST600	6.0 Mtrs	0	0	0	0
Trapdoor Platform	PT200	2.0 Mtrs	1	2	3	4
Toe Board	BT200	Set	1	1	1	1

# BS1139-6:2014 Certification by TUV India



## Statement of Confirmation

No.: CE/21-22/046

Client's Reference – EN-AS-BS-2122-000

Name & Address of the Manufacturer:

**AFFIX SCAFFOLDING.**

Hugo Building, Office No.13  
Opp Old Fatihima Shopping Centre  
Umm Dom Stree, Muaither, Doha , Qatar

Product Type:

- Cantilever Tower
- Bridgeway Tower
- Stair Tower

Review Results/Observations:

The Technical File referenced above submitted by the manufacturer has been reviewed for its document contents – the above product/s, generally comply with the Safety requirements of the British Standards:

### BS-1139-6:2014

Validity: 15 November 2024 (Subject to annual factory production control audits)



**Mahesh Gaur**  
General Manager - Product Certification and Product Testing Laboratory

(This Statement of Confirmation is valid under the conditions stated overleaf)

Registered & Head Office: 801, Raheja Plaza I, LBS Marg, Ghatkopar (W), Mumbai 400 086 | Email: infoindia@tuv-nord.com Tel: +91-22-66477000  
Website: www.tuv-nord.com/in Toll Free Number: 1800-209-0902

Job no: 8119218584



**PO Box No. 201633 Doha, Qatar**

**Tel +974 4416 1483    Mobile +974 5529 9893**

**Mobile +974 3030 0685**

**Email : info@affixscaffolding.com**

**Website: www.affixscaffolding.com**

**To Check Assembly Video**

**SCAN ME**

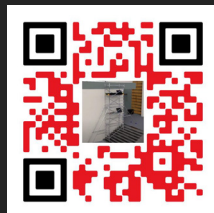

**<https://qrco.de/bcPyx6>**

 **<https://twitter.com/affixscaffoldin>**

 **<https://www.facebook.com/affixscaffoldin>**

 **<https://www.linkedin.com/company/affix-scaffolding-llc/>**